

▲ Heizkörper

Stylos freistehende Version 660↑ x 646↔ LP,

Farbe: antique brass,

Produkt- und Konfigurationscode: WG4SF066064 LAN5LP

192 RAL-FARBEN UND SPE-
ZIELLE FARBPALETTE SPEZIELL
FÜR GUSHEIZKÖRPER



STYLOS 





VERFÜGBARE GRÖSSEN

WANDMONTIERTE VERSION



600 x 60
 ↓ ←



600 x 216

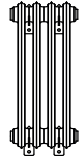

600 x 277

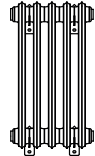

600 x 339

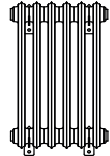

600 x 400

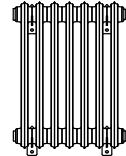

600 x 462

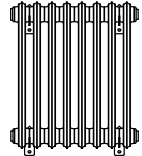

600 x 523

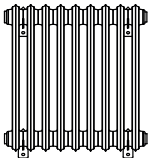

600 x 589
 ↓ ←

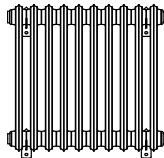

600 x 646

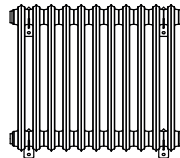

600 x 708

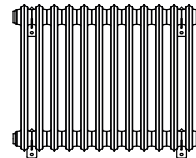

600 x 769

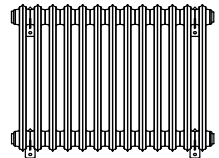

600 x 831

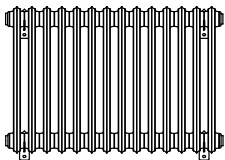

600 x 892
 ↓ ←

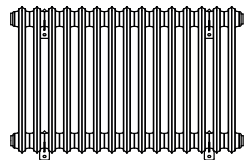

600 x 954

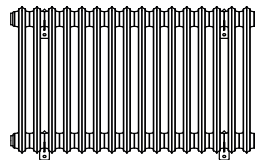

600 x 1015

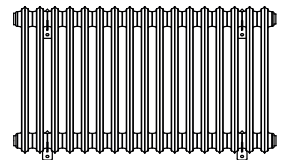

600 x 1077

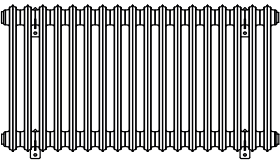

600 x 1138
 ↓ ←

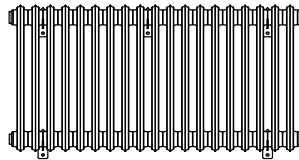

600 x 1200

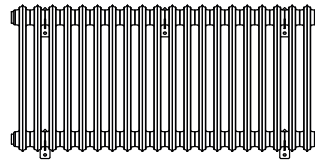

600 x 1261

VERFÜGBARE GRÖSSEN

WANDMONTIERTE VERSION



700 x 60
 ↓ ↔

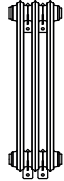

700 x 216

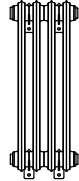

700 x 277

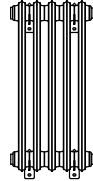

700 x 339

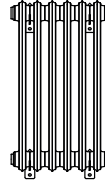

700 x 400

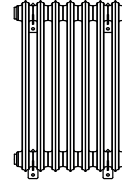

700 x 462

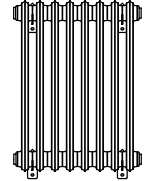

700 x 523

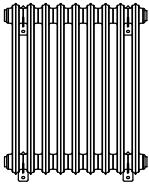

700 x 589
 ↓ ↔

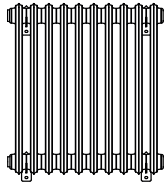

700 x 646

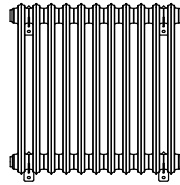

700 x 708

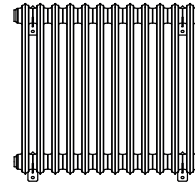

700 x 769

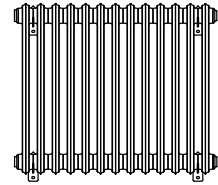

700 x 831

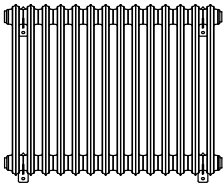

700 x 892
 ↓ ↔

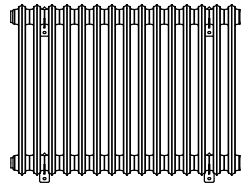

700 x 954

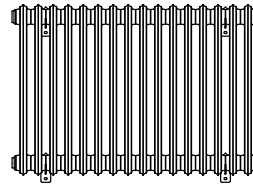

700 x 1015

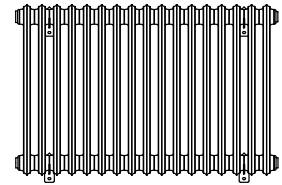

700 x 1077

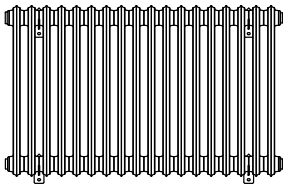

700 x 1138
 ↓ ↔

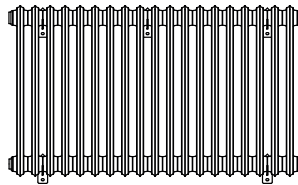

700 x 1200

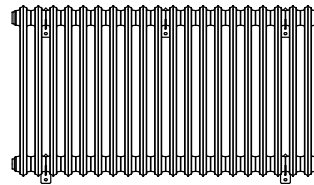

700 x 1261

VERFÜGBARE GRÖSSEN

FREISTEHENDE VERSION



660 x 60
 ↓ ↔



660 x 216

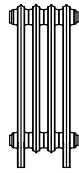

660 x 277

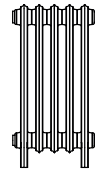

660 x 339

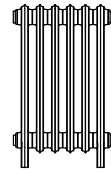

660 x 400

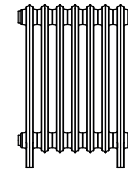

660 x 462

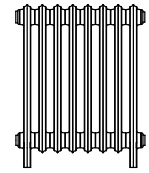

660 x 523

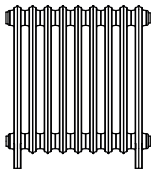

660 x 585
 ↓ ↔

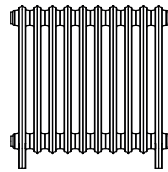

660 x 646

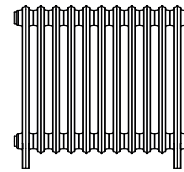

660 x 708

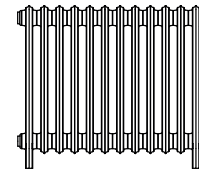

660 x 769

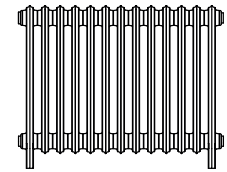

660 x 831

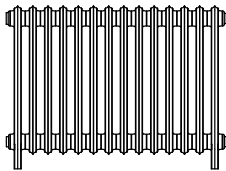

660 x 892
 ↓ ↔

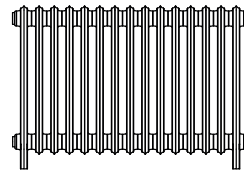

660 x 954

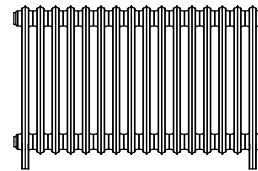

660 x 1015

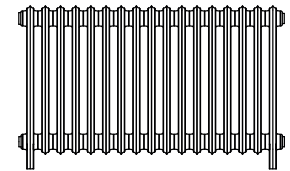

660 x 1077

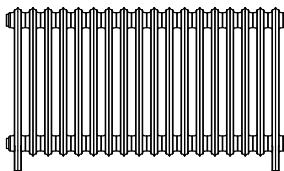

660 x 1138
 ↓ ↔

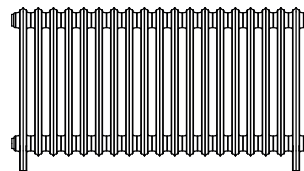

660 x 1200

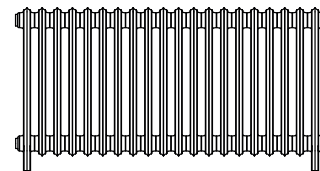

660 x 1261

VERFÜGBARE GRÖSSEN

FREISTEHENDE VERSION



760 x 60
 ↓ ↔



760 x 216

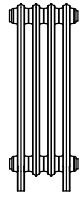

760 x 277



760 x 339



760 x 400

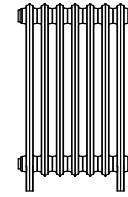

760 x 462

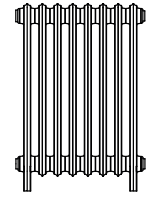

760 x 523

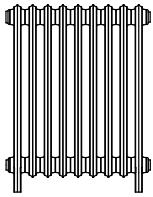

760 x 585
 ↓ ↔

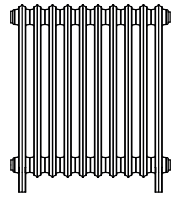

760 x 646

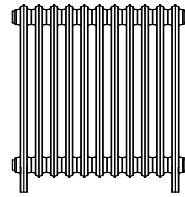

760 x 708

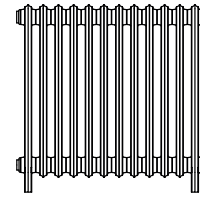

760 x 769

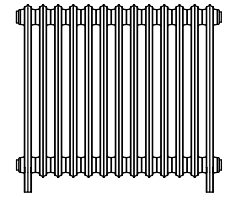

760 x 831

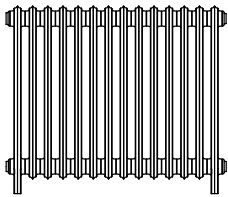

760 x 892
 ↓ ↔

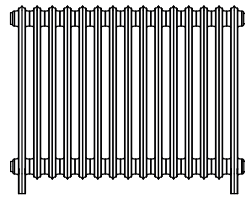

760 x 954

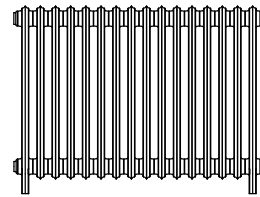

760 x 1015

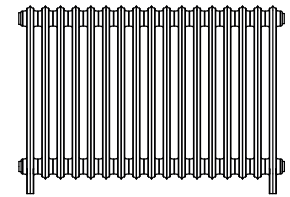

760 x 1077

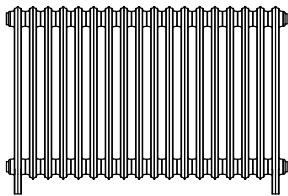

760 x 1138
 ↓ ↔

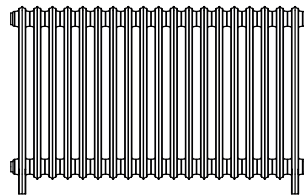

760 x 1200

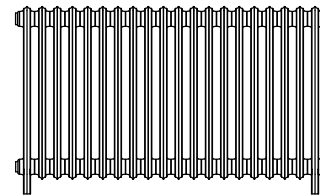

760 x 1261

AUSGANG – WANDVERSION

ZENTRALHEIZUNGS-WASSERKÜHLER

Verbindungen:





Anzahl der Abschnitte	Höhe A ⇕ [mm]	Breite B ⇔ [mm]	Heizleistung		Produktcode ... Konfigurationscode, Infoseite 13
			75/65/20°C [W]	55/45/20°C [W]	
3	600	216	256	135	WG4SB060021...
4	600	277	341	180	WG4SB060027...
5	600	339	427	225	WG4SB060033...
6	600	400	512	270	WG4SB060040...
7	600	462	597	315	WG4SB060046...
8	600	523	682	360	WG4SB060052...
9	600	585	768	405	WG4SB060058...
10	600	646	853	450	WG4SB060064...
11	600	708	938	495	WG4SB060070...
12	600	769	1024	540	WG4SB060076...
13	600	831	1109	585	WG4SB060083...
14	600	892	1194	630	WG4SB060089...
15	600	954	1280	675	WG4SB060095...
16	600	1015	1365	720	WG4SB060101...
17	600	1077	1450	765	WG4SB060107...
18	600	1138	1535	810	WG4SB060113...
19	600	1200	1621	855	WG4SB060120...
20	600	1261	1706	900	WG4SB060126...
3	700	216	307	159	WG4SB070021...
4	700	277	410	212	WG4SB070027...
5	700	339	512	265	WG4SB070033...
6	700	400	614	317	WG4SB070040...
7	700	462	717	370	WG4SB070046...
8	700	523	819	423	WG4SB070052...
9	700	585	922	476	WG4SB070058...
10	700	646	1024	529	WG4SB070064...
11	700	708	1126	582	WG4SB070070...
12	700	769	1229	635	WG4SB070076...
13	700	831	1331	688	WG4SB070083...
14	700	892	1434	741	WG4SB070089...
15	700	954	1536	794	WG4SB070095...
16	700	1015	1638	846	WG4SB070101...
17	700	1077	1741	899	WG4SB070107...
18	700	1138	1843	952	WG4SB070113...
19	700	1200	1946	1005	WG4SB070120...
20	700	1261	2048	1058	WG4SB070126...

TECHNISCHE DETAILS

Arbeitsdruck: 1000 kPa

Maximale Arbeitstemperatur: 95°C

Anzahl der Abschnitte	Höhe A ↕ [mm]	Breite B ↔ [mm]	C [mm]	D [mm]	D' [mm]	Kapazität  [dm³]	Gewicht  [kg]
Wandmontierte Version							
3	600	216	500	–	77	2,43	17,26
4	600	277	500	123	77	3,24	22,68
5	600	339	500	185	77	4,05	28,15
6	600	400	500	246	77	4,86	33,57
7	600	462	500	308	77	5,67	39,04
8	600	523	500	369	77	6,48	44,46
9	600	585	500	431	77	7,29	49,93
10	600	646	500	492	77	8,10	55,35
11	600	708	500	554	77	8,91	60,82
12	600	769	500	615	77	9,72	66,24
13	600	831	500	677	77	10,53	71,71
14	600	892	500	738	77	11,34	77,13
15	600	954	500	676	139	12,15	82,60
16	600	1015	500	737	139	12,96	88,02
17	600	1077	500	799	139	13,77	93,49
18	600	1138	500	860	139	14,58	98,91
19	600	1200	500	922	139	15,39	104,38
20	600	1261	500	983	139	16,20	109,80
3	700	216	600	–	77	3,00	20,53
4	700	277	600	123	77	4,00	27,04
5	700	339	600	185	77	5,00	33,60
6	700	400	600	246	77	6,00	40,11
7	700	462	600	308	77	7,00	46,67
8	700	523	600	369	77	8,00	53,18
9	700	585	600	431	77	9,00	59,74
10	700	646	600	492	77	10,00	66,25
11	700	708	600	554	77	11,00	72,82
12	700	769	600	615	77	12,00	79,32
13	700	831	600	677	77	13,00	85,88
14	700	892	600	738	77	14,00	92,39
15	700	954	600	676	139	15,00	98,95
16	700	1015	600	737	139	16,00	105,46
17	700	1077	600	799	139	17,00	112,02
18	700	1138	600	860	139	18,00	118,53
19	700	1200	600	922	139	19,00	125,09
20	700	1261	600	983	139	20,00	131,60

WYDAJNOŚĆ – FREISTEHENDE VERSION

ZENTRALHEIZUNGS-WASSERKÜHLER

Verbindungen:





Anzahl der Abschnitte	Höhe A ↓ [mm]	Breite B ↔ [mm]	Heizleistung		Produktcode <small>... Konfigurationscode, Infoseite 13</small>
			75/65/20°C [W]	55/45/20°C [W]	
3	660	216	256	135	WG4SF066021...
4	660	277	341	180	WG4SF066027...
5	660	339	427	225	WG4SF066033...
6	660	400	512	270	WG4SF066040...
7	660	462	597	315	WG4SF066046...
8	660	523	682	360	WG4SF066052...
9	660	585	768	405	WG4SF066058...
10	660	646	853	450	WG4SF066064...
11	660	708	838	495	WG4SF066070...
12	660	769	1024	540	WG4SF066076...
13	660	831	1109	585	WG4SF066083...
14	660	892	1194	630	WG4SF066089...
15	660	954	1280	675	WG4SF066095...
16	660	1015	1365	720	WG4SF066101...
17	660	1077	1450	765	WG4SF066107...
18	660	1138	1535	810	WG4SF066113...
19	660	1200	1621	855	WG4SF066120...
20	660	1261	1706	900	WG4SF066126...
3	760	216	307	159	WG4SF076021...
4	760	277	410	212	WG4SF076027...
5	760	339	512	265	WG4SF076033...
6	760	400	614	317	WG4SF076040...
7	760	462	717	370	WG4SF076046...
8	760	523	819	423	WG4SF076052...
9	760	585	922	476	WG4SF076058...
10	760	646	1024	529	WG4SF076064...
11	760	708	1126	582	WG4SF076070...
12	760	769	1229	635	WG4SF076076...
13	760	831	1331	688	WG4SF076083...
14	760	892	1434	741	WG4SF076089...
15	760	954	1536	794	WG4SF076095...
16	760	1015	1638	846	WG4SF076101...
17	760	1077	1741	899	WG4SF076107...
18	760	1138	1843	952	WG4SF076113...
19	760	1200	1946	1005	WG4SF076120...
20	760	1261	2048	1058	WG4SF076126...

TECHNISCHE DETAILS

Arbeitsdruck: 1000 kPa

Maximale Arbeitstemperatur: 95°C

Anzahl der Abschnitte	Höhe A \updownarrow [mm]	Breite B \leftrightarrow [mm]	C [mm]	D [mm]	D1 [mm]	Kapazität  [dm ³]	Gewicht  [kg]
Freistehende Version							
3	660	216	500	–	–	2,43	18,14
4	660	277	500	–	–	3,24	23,56
5	660	339	500	–	–	4,05	29,03
6	660	400	500	–	–	4,86	34,45
7	660	462	500	–	–	5,67	39,92
8	660	523	500	–	–	6,48	45,34
9	660	585	500	–	–	7,29	50,81
10	660	646	500	–	–	8,10	56,23
11	660	708	500	–	–	8,91	61,70
12	660	769	500	–	–	9,72	67,12
13	660	831	500	–	–	10,53	72,59
14	660	892	500	–	–	11,34	78,01
15	660	954	500	–	–	12,15	83,48
16	660	1015	500	–	–	12,96	88,90
17	660	1077	500	–	–	13,77	94,37
18	660	1138	500	–	–	14,58	99,79
19	660	1200	500	–	–	15,39	105,26
20	660	1261	500	–	–	16,20	110,68
3	760	216	600	–	–	3,00	21,49
4	760	277	600	–	–	4,00	28,00
5	760	339	600	–	–	5,00	34,56
6	760	400	600	–	–	6,00	41,07
7	760	462	600	–	–	7,00	47,63
8	760	523	600	–	–	8,00	54,14
9	760	585	600	–	–	9,00	60,70
10	760	646	600	–	–	10,00	67,21
11	760	708	600	–	–	11,00	73,77
12	760	769	600	–	–	12,00	80,28
13	760	831	600	–	–	13,00	86,84
14	760	892	600	–	–	14,00	93,35
15	760	954	600	–	–	15,00	99,91
16	760	1015	600	–	–	16,00	106,42
17	760	1077	600	–	–	17,00	112,98
18	760	1138	600	–	–	18,00	119,49
19	760	1200	600	–	–	19,00	126,05
20	760	1261	600	–	–	20,00	132,56

TECHNISCHE ZEICHNUNG

WANDMONTIERTE VERSION

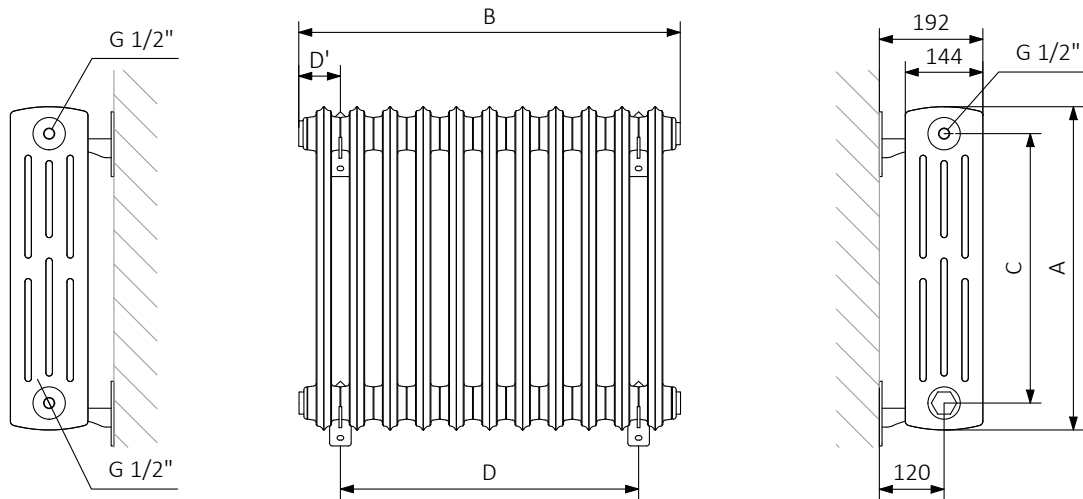

FREISTEHENDE VERSION

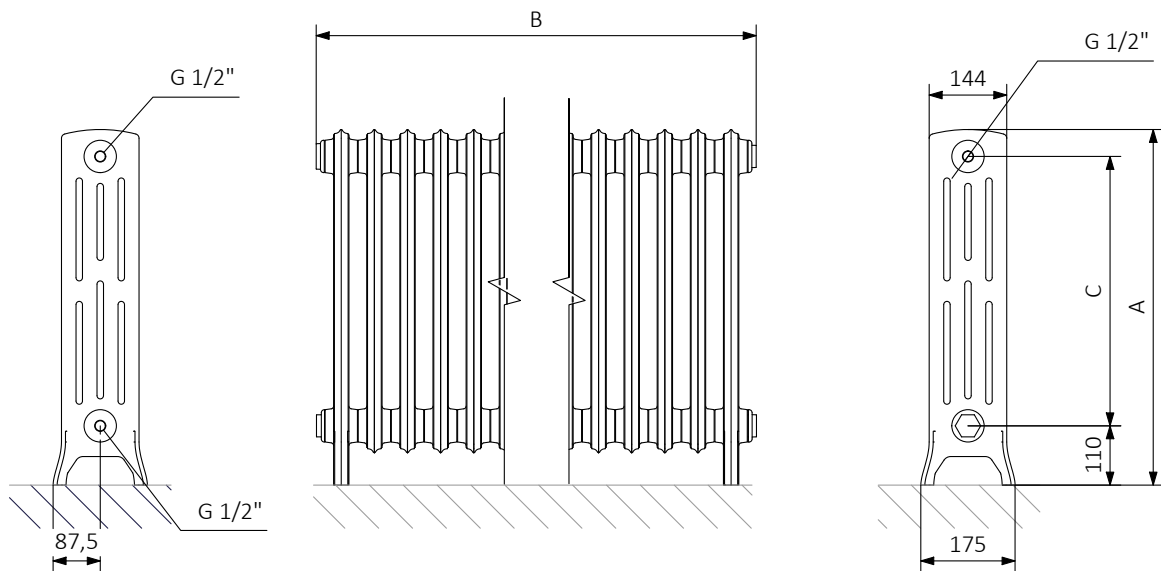

A – Höhe B – Breite C – Verbindungsentfernung D – Abstand der unteren Halterungen D' - Abstand von höheren Aufhängungen

STRUKTUR DES KONFIGURATIONSCODES – ZENTRALHEIZUNGS- WASSERKÜHLER (PRODUKTGRUPPE „WG“)

Die Tabellen auf den technischen Datenblättern der Produkte enthalten Produktcodes, die grundlegende Informationen zu den Produkten liefern, sowie einen teilweise ausgefüllten Konfigurationscode, der die Informationen durch detaillierte Produktspezifikationen ergänzt. Um die Bestellung abzuschließen, müssen die Produktcodes um den vollständigen Konfigurationscode ergänzt werden. Der Konfigurationscode sollte nach dem Produktcode platziert werden. Nachfolgend stellen wir die Struktur des Produktcodes und des Konfigurationscodes vor.

CODESTRUKTUR:

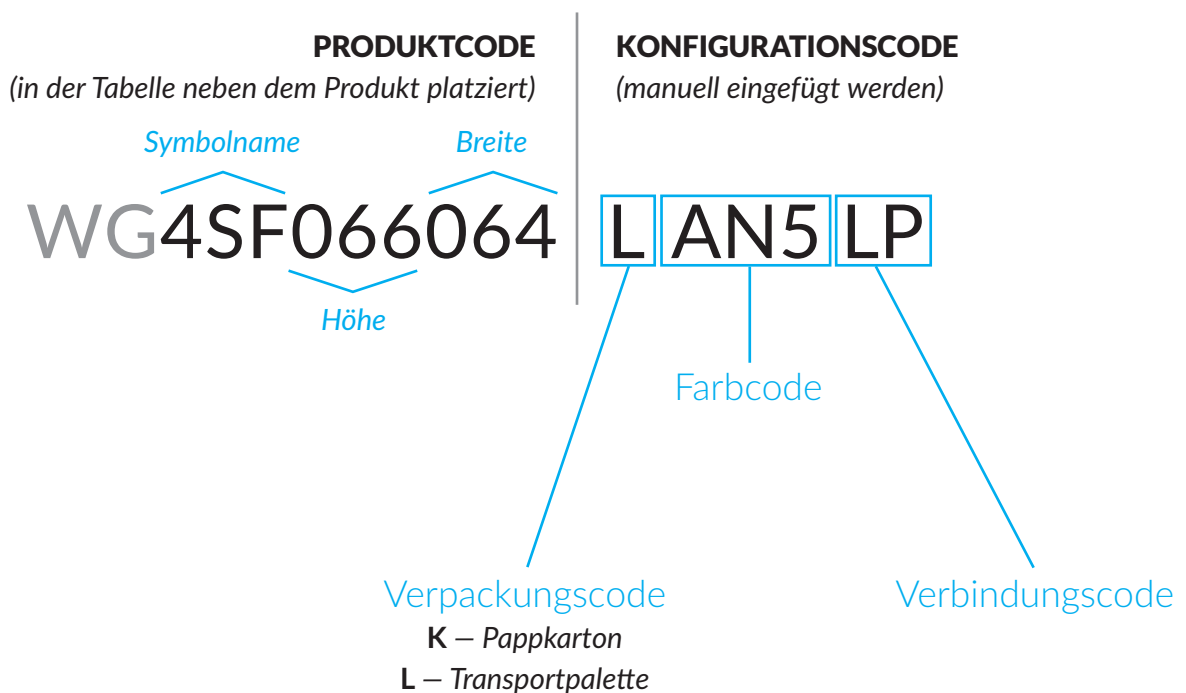

PALETTE VON OBERFLÄCHEN FÜR GUSSHEIZKÖRPER

Zusätzlich zur Palette von 192 Standard-RAL-Farben (Nasslackierung) bieten wir eine Palette an Sonderfarben und eine Reihe dekorativer Veredelungen an. Auf besonderen Wunsch des Kunden fertigen wir Heizkörper und Zubehör auch in individuell ausgewählten Ausführungen an.

SPEZIELLE FARBPALETTE

GRUPPE 1



WHITE SOFT

WS3



FROST

FR3



METALLIC BROWN

AB3



AUTUMN

AU3



EVENING GARDEN

EG3



SHADOW GOLD

SG3



GRAFF

GR3



FLAT BLACK

FB3



RAW METAL

ZE3



METAL ALIVE

ZE1



PALETA RAL

GRUPPE 2



ANTIQUÉ COPPER

AC5



ANTIQUÉ BRASS

AN5



FULL BURNISH

FB2



BOTTLE GREEN

BGR

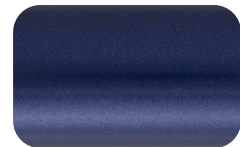

MIDNIGHT

MDN



SHADED BURNISH

FB4



RED WINE

RWE

GRUPPE 3



ORNAMENT GOLD*

GR7



ORNAMENT SILVER*

GR9



ORNAMENT COPPER*

GR8



GALVANIC COPPER

GC5

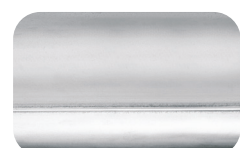































































































































































































POLISHED METAL

ZE2

* Das freigelegte Ornament kann auf einer beliebigen Farbe aus der Palette der Gruppe 1 erstellt werden

RAL-FARBPALETTE

 100 – RAL 1000	 302 – RAL 3002	 511 – RAL 5011	 627 – RAL 6027	 745 – RAL 7045
 101 – RAL 1001	 303 – RAL 3003	 512 – RAL 5012	 628 – RAL 6028	 746 – RAL 7046
 102 – RAL 1002	 304 – RAL 3004	 513 – RAL 5013	 629 – RAL 6029	 747 – RAL 7047
 103 – RAL 1003	 305 – RAL 3005	 514 – RAL 5014	 632 – RAL 6032	 800 – RAL 8000
 104 – RAL 1004	 307 – RAL 3007	 515 – RAL 5015	 633 – RAL 6033	 801 – RAL 8001
 105 – RAL 1005	 309 – RAL 3009	 517 – RAL 5017	 634 – RAL 6034	 802 – RAL 8002
 106 – RAL 1006	 311 – RAL 3011	 518 – RAL 5018	 700 – RAL 7000	 803 – RAL 8003
 107 – RAL 1007	 312 – RAL 3012	 519 – RAL 5019	 701 – RAL 7001	 804 – RAL 8004
 111 – RAL 1011	 313 – RAL 3013	 520 – RAL 5020	 702 – RAL 7002	 807 – RAL 8007
 112 – RAL 1012	 314 – RAL 3014	 521 – RAL 5021	 703 – RAL 7003	 808 – RAL 8008
 113 – RAL 1003	 315 – RAL 3015	 522 – RAL 5022	 704 – RAL 7004	 811 – RAL 8011
 114 – RAL 1014	 316 – RAL 3016	 523 – RAL 5023	 705 – RAL 7005	 812 – RAL 8012
 115 – RAL 1015	 317 – RAL 3017	 524 – RAL 5024	 706 – RAL 7006	 814 – RAL 8014
 116 – RAL 1016	 318 – RAL 3018	 600 – RAL 6000	 708 – RAL 7008	 815 – RAL 8015
 117 – RAL 1017	 320 – RAL 3020	 601 – RAL 6004	 709 – RAL 7009	 816 – RAL 8016
 118 – RAL 1018	 322 – RAL 3022	 602 – RAL 6002	 710 – RAL 7010	 817 – RAL 8017
 119 – RAL 1019	 327 – RAL 3027	 603 – RAL 6003	 711 – RAL 7011	 819 – RAL 8019
 120 – RAL 1020	 328 – RAL 3028	 604 – RAL 6004	 712 – RAL 7012	 822 – RAL 8022
 121 – RAL 1021	 331 – RAL 3031	 605 – RAL 6005	 713 – RAL 7013	 823 – RAL 8023
 123 – RAL 1023	 401 – RAL 4001	 606 – RAL 6006	 715 – RAL 7015	 824 – RAL 8024
 124 – RAL 1024	 402 – RAL 4002	 607 – RAL 6007	 716 – RAL 7016	 825 – RAL 8025
 127 – RAL 1027	 403 – RAL 4003	 608 – RAL 6008	 721 – RAL 7021	 828 – RAL 8028
 128 – RAL 1028	 404 – RAL 4004	 609 – RAL 6009	 722 – RAL 7022	 901 – RAL 9001
 132 – RAL 1032	 405 – RAL 4005	 610 – RAL 6010	 723 – RAL 7023	 902 – RAL 9002
 133 – RAL 1033	 406 – RAL 4006	 611 – RAL 6011	 724 – RAL 7024	 903 – RAL 9003
 134 – RAL 1034	 407 – RAL 4007	 612 – RAL 6012	 726 – RAL 7026	 904 – RAL 9004
 137 – RAL 1037	 408 – RAL 4008	 613 – RAL 6013	 730 – RAL 7030	 9M5 – RAL 9005
 200 – RAL 2000	 409 – RAL 4009	 614 – RAL 6014	 732 – RAL 7032	 906 – RAL 9006
 201 – RAL 2001	 410 – RAL 4010	 615 – RAL 6015	 733 – RAL 7033	 907 – RAL 9007
 202 – RAL 2002	 500 – RAL 5000	 616 – RAL 6016	 734 – RAL 7034	 910 – RAL 9010
 203 – RAL 2003	 501 – RAL 5001	 617 – RAL 6017	 735 – RAL 7035	 911 – RAL 9011
 204 – RAL 2004	 502 – RAL 5002	 618 – RAL 6018	 736 – RAL 7036	 916 – RAL 9016
 208 – RAL 2008	 503 – RAL 5003	 619 – RAL 6019	 737 – RAL 7037	 917 – RAL 9017
 209 – RAL 2009	 504 – RAL 5004	 620 – RAL 6020	 738 – RAL 7038	 918 – RAL 9018
 210 – RAL 2010	 505 – RAL 5005	 621 – RAL 6021	 739 – RAL 7039	
 211 – RAL 2011	 507 – RAL 5007	 622 – RAL 6022	 740 – RAL 7040	
 212 – RAL 2012	 508 – RAL 5008	 624 – RAL 6024	 742 – RAL 7042	
 300 – RAL 3000	 509 – RAL 5009	 625 – RAL 6025	 743 – RAL 7043	
 301 – RAL 3001	 510 – RAL 5010	 626 – RAL 6026	 744 – RAL 7044	